

# WBPF-D012

## Electrical Specifications

Parameter	Frequency [MHz]	Specification -40°C to 85°C	Typical Value @25°C
Center Frequency	3200		
Band Width	150		
Insertion Loss	3125 – 3275	2.0dB max	0.7dB
Passband Ripple	3125 – 3275	0.5dB max	0.2dB
Return Loss	3125 – 3275	15dB min	18dB
Attenuation			
Impedance		50 Ohm	50 Ohm
Input power		1Watt max	

## Electrical Performance

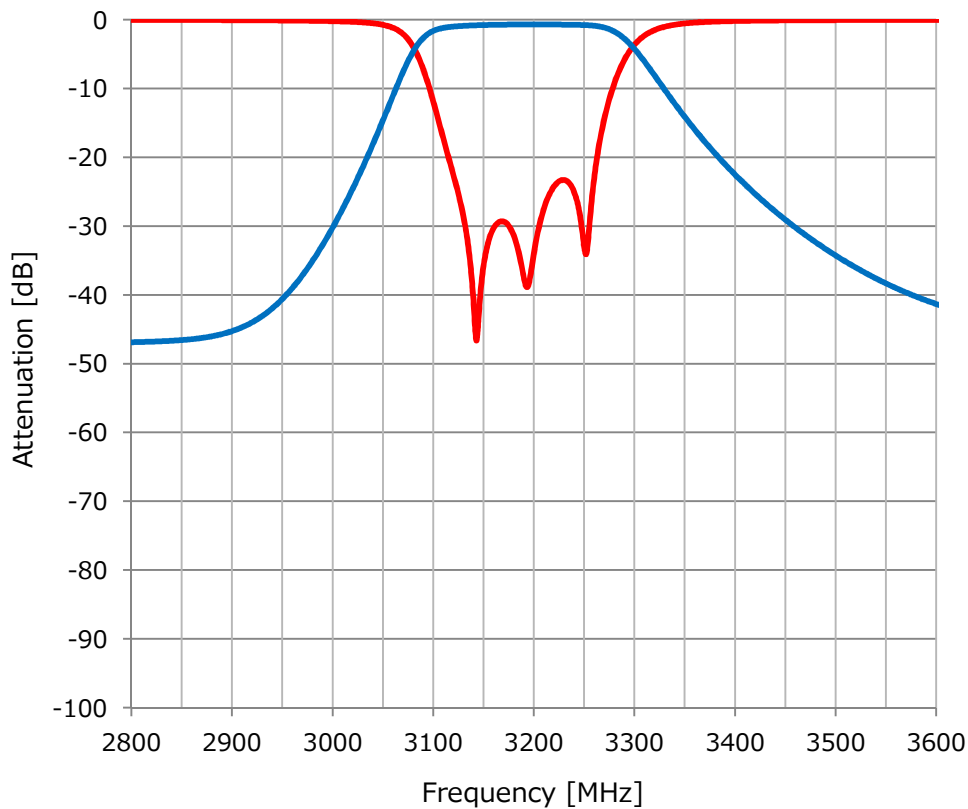

Mechanical Dimension

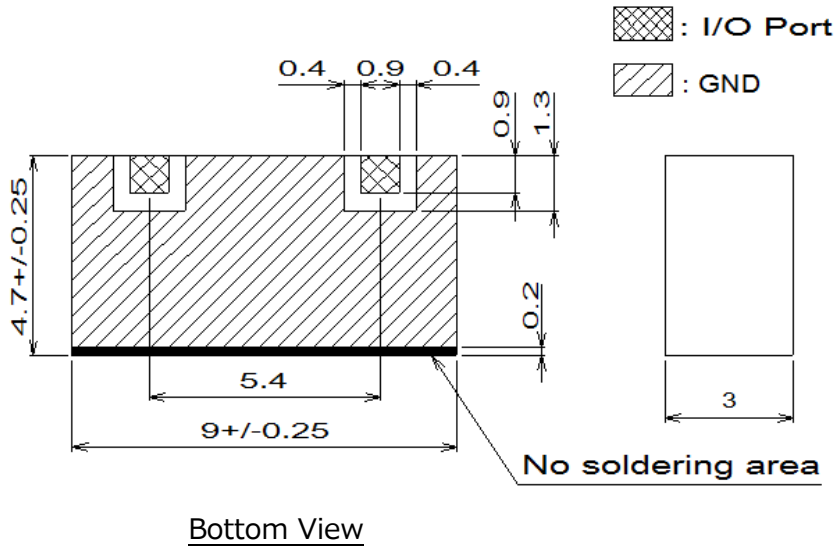

Tolerance unless otherwise specified : +/-0.2mm

Referenced Land Pattern

