

WBPF-D007

Electrical Specifications

Parameter	Frequency [MHz]	Specification -40°C to 85°C	Typical Value @25°C
Center Frequency	2990		
Band Width	60		
Insertion Loss	2960 – 3020	2.1dB max	1.6dB
Passband Ripple	2960 – 3020	0.7dB max	0.3dB
VSWR	2960 – 3020	1.7 max	1.5
Attenuation			
Impedance		50 Ohm	50 Ohm
Input power		1Watt max	

Electrical Performance

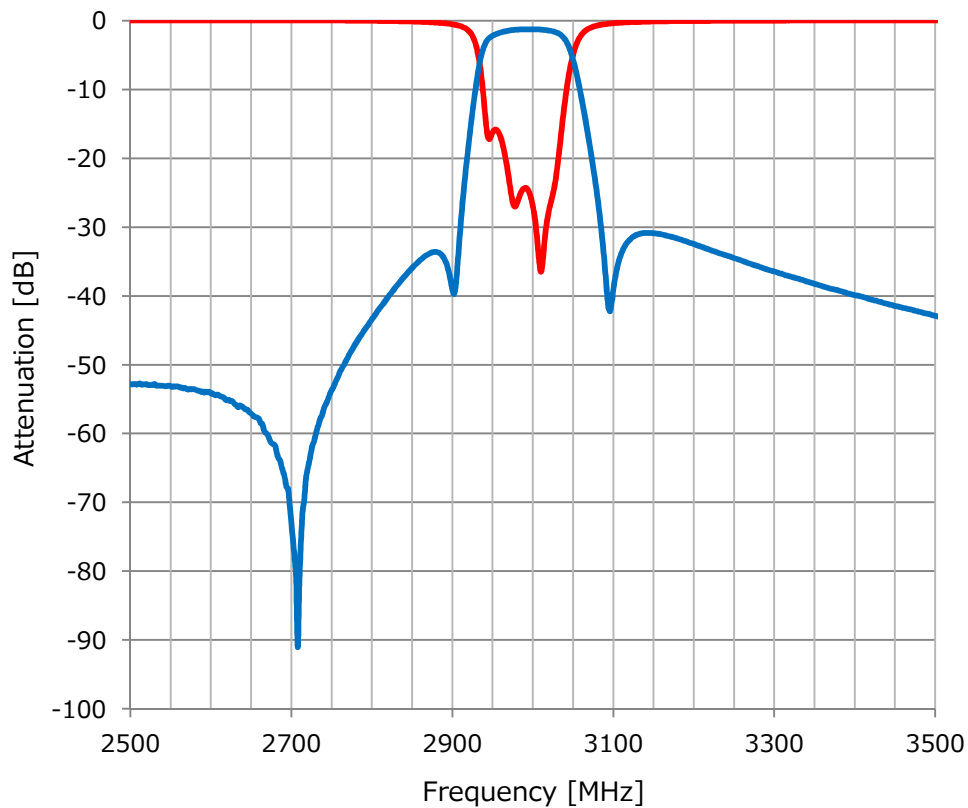

Mechanical Dimension

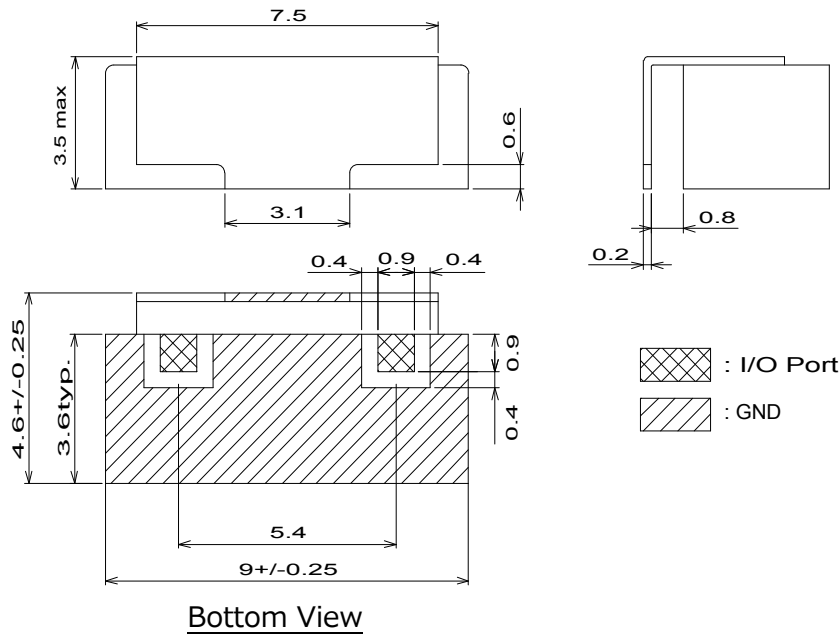

Units : mm

Tolerance unless otherwise specified : +/-0.2mm

Referenced Land Pattern

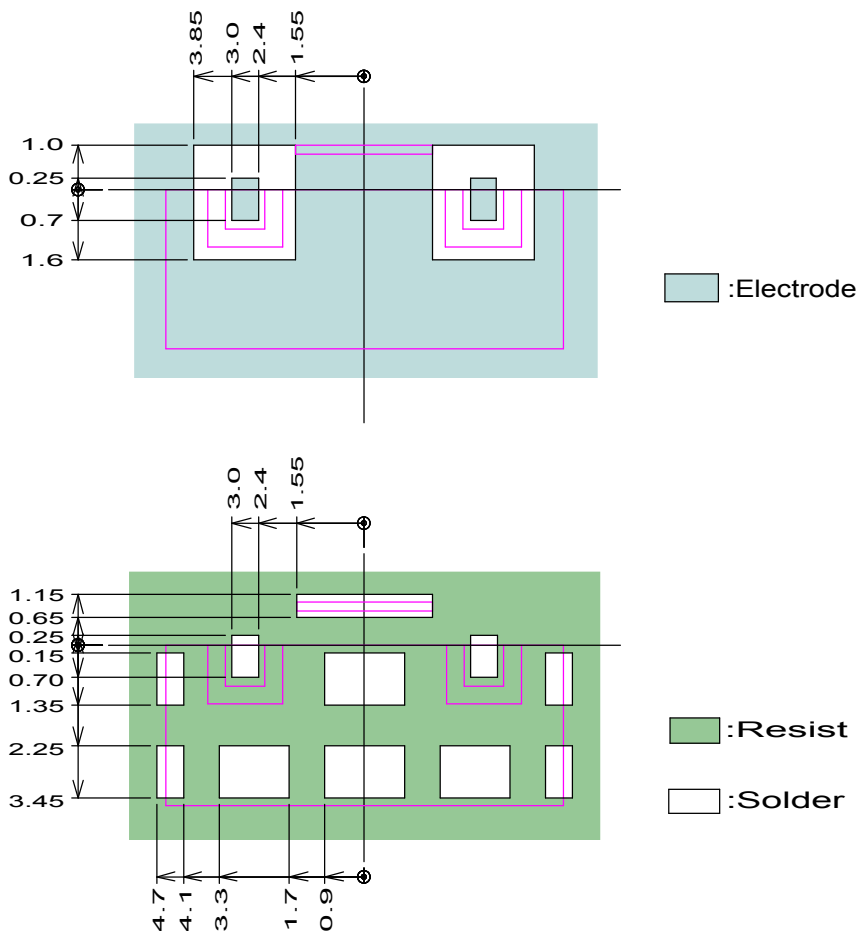

Units : mm