

WBPF-D002

Electrical Specifications

Parameter	Frequency [MHz]	Specification -40°C to 85°C	Typical Value @25°C
Center Frequency	4700		
Band Width	200		
Insertion Loss	4600 – 4800	2.5dB max	1.8dB
Passband Ripple	4600 – 4800	1.2dB max	0.6dB
Return Loss	4600 – 4800	10dB min	14dB
Attenuation			
Impedance		50 Ohm	50 Ohm
Input power		1Watt max	

Electrical Performance

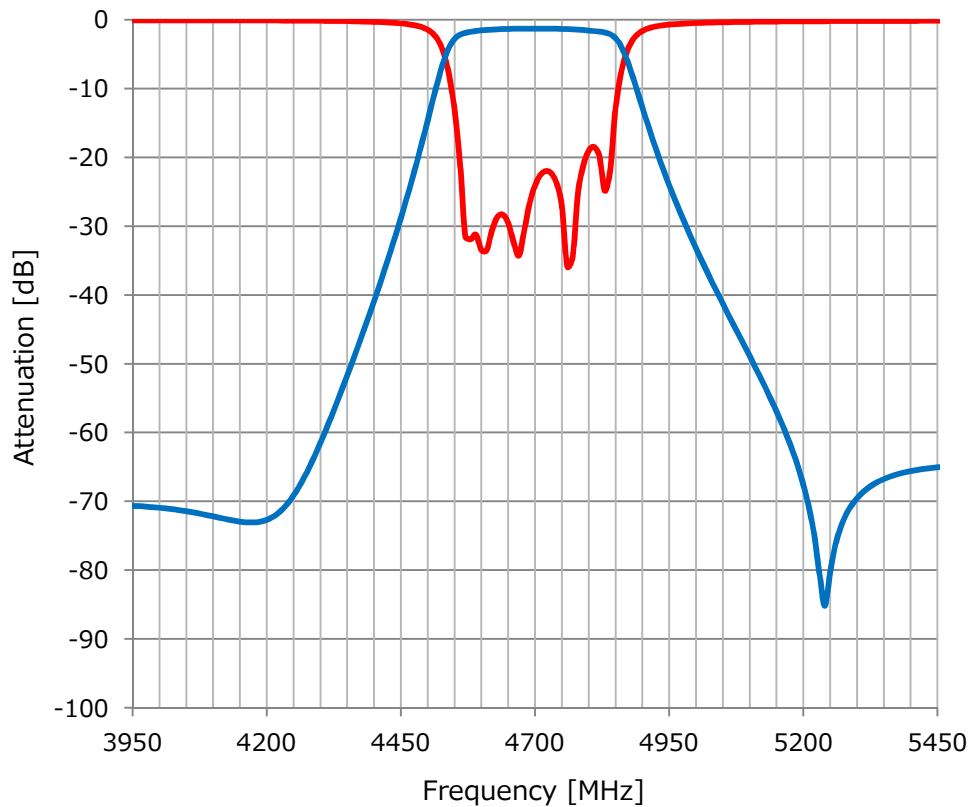

Mechanical Dimension

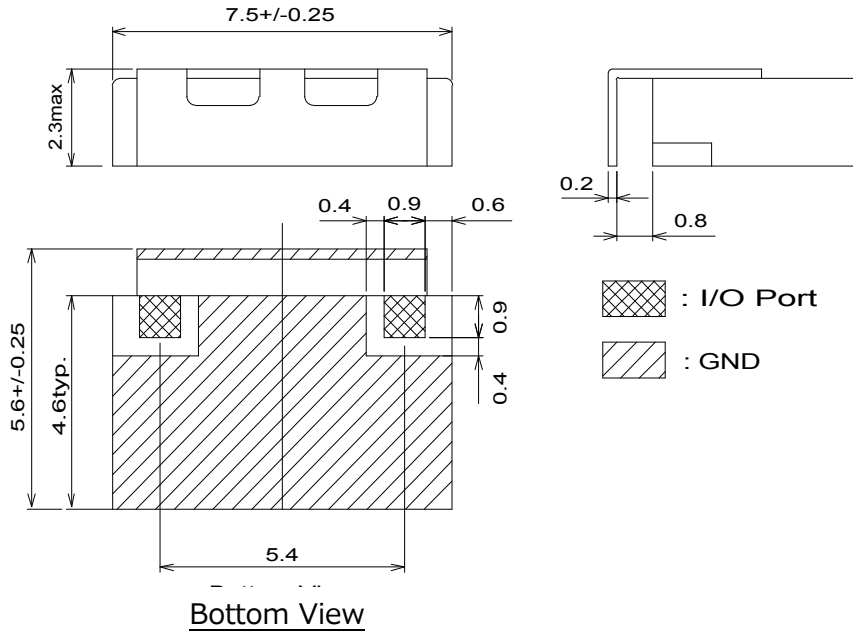

Units : mm

Tolerance unless otherwise specified : ± 0.2 mm

Referenced Land Pattern

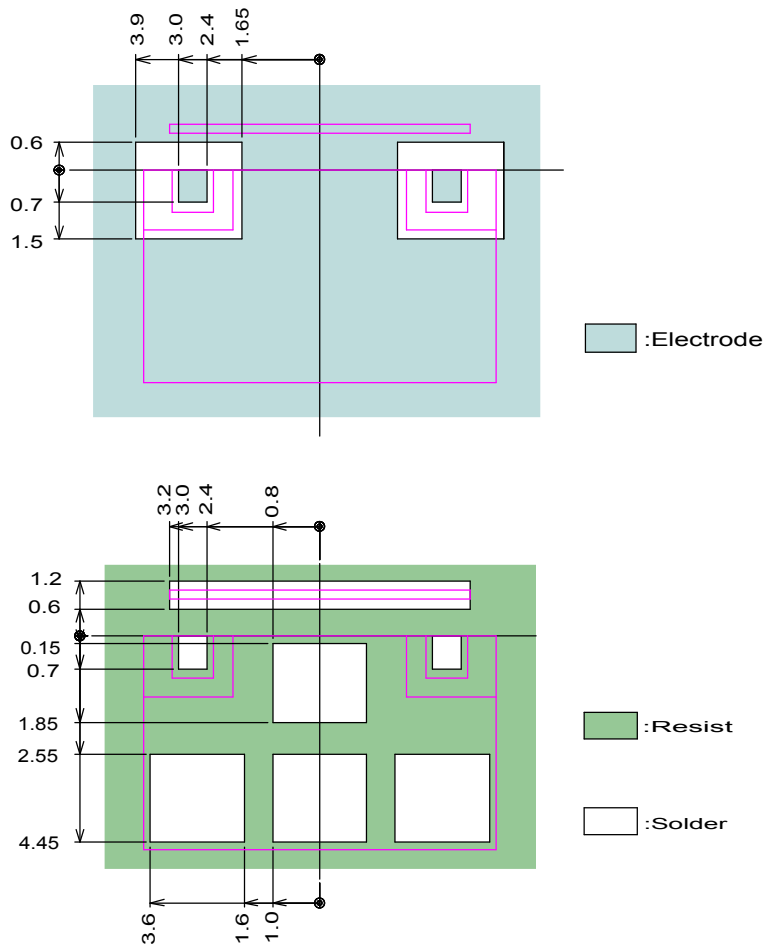

Units : mm