

# WBPF-A006

## Electrical Specifications

Parameter	Frequency [MHz]	Specification -40°C to 85°C	Typical Value @25°C
Center Frequency	3600		
Band Width	400		
Insertion Loss	3400 – 3800	2.0dB max	1.2dB
Passband Ripple	3400 – 3800	2.0dB max	0.5dB
VSWR	3400 – 3800	2.0 max	1.5
Attenuation			
Impedance		50 Ohm	50 Ohm
Input power		2Watt max	

## Electrical Performance

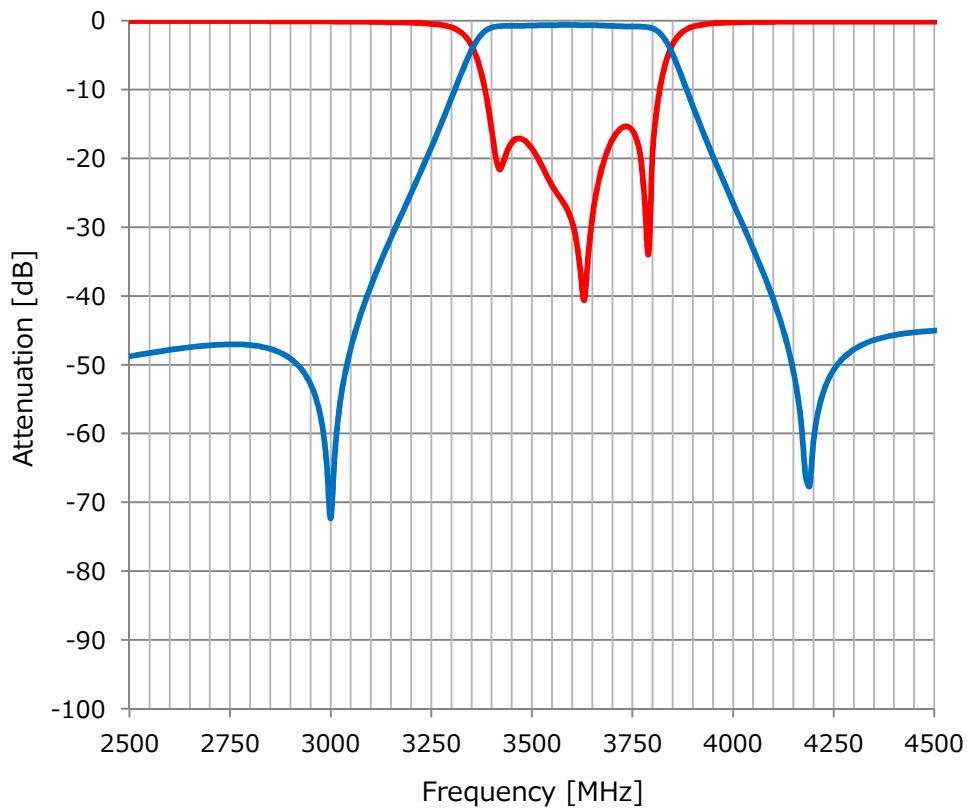

Mechanical Dimension

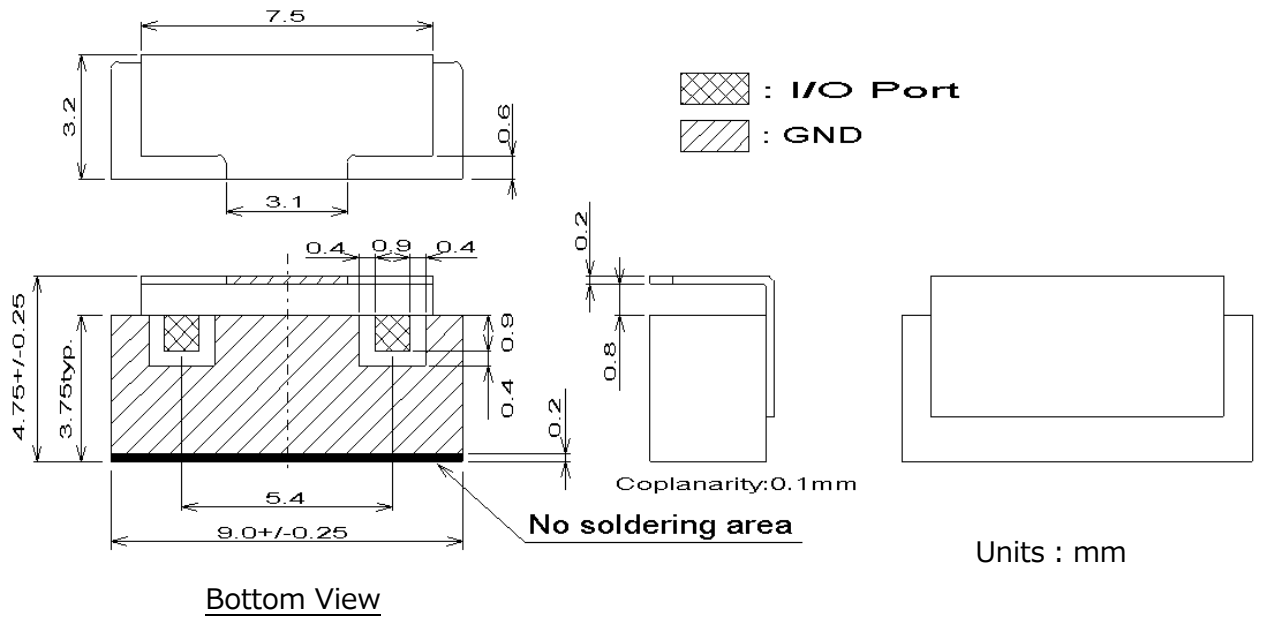

Tolerance unless otherwise specified : +/-0.2mm

Referenced Land Pattern

